

Mount the bracket in the wall in upright position above the water container (which contains a solution of pH reducing acid and water).

Place the pump in vertical position (with the tubes below) on the wall, above and centered with the "Mounting bracket". Then go down the pump until it is joined with the bracket.

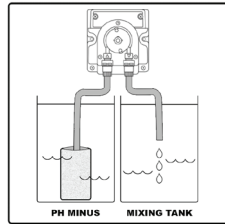

Connect the pump to the MC122 pH controller (on the black and white outlet). The pump will discharge 0,08 cL every 2 seconds.

Place the plug and B/W outlet far away from water!

Before servicing (maintenance) on the pump (e.g. changing tube), please disconnect the equipment.

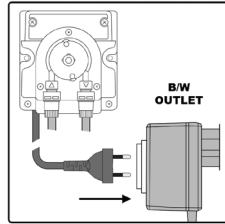

It is suggested to dissolve 10 cL of pH reducing acid in a 5L container of mineral water. Depending on the volume of your tank and the brand of you pH reducing acid (if it is more or less concentrated), this quantity will be balanced. It is better to dissolve more than less. It is suggested to use an airstone on the bottom of your tank. The pump can be attached directly to the container of the solution.

OPTIONAL ACCESSORIES:

- M10004B** pH 4.01 buffer solution, 20 ml sachet (25 pcs)
- M10007B** pH 7.01 buffer solution, 20 ml sachet (25 pcs)
- M10010B** pH 10.01 buffer solution, 20 ml sachet (25 pcs)
- M10000B** Electrode rinse solution, 20 ml sachet (25 pcs)
- MA9015** Electrode storage solution, 20 ml sachet (25 pcs)

WARRANTY:

These instruments are warranted from all defects in materials and manufacturing for a period of two years from the date of purchase. The electrode is warranted for a period of 6 months. If during this period, the repair or replacement of parts is required, where the damage is not due to negligence or erroneous operation by the user, please return the parts to either dealer or our office and the repair will be effected free of charge.

Note: We reserve the right to modify the design, construction and appearance of our products without advance notice.



www.milwaukeeinstruments.com



USER MANUAL

MC720 MILWAUKEE MC122 PH CONTROLLER WITH MP810 1,5 L/H DOSING PUMP

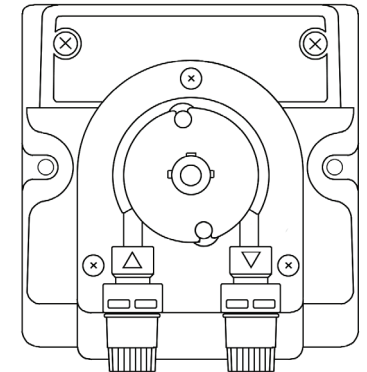
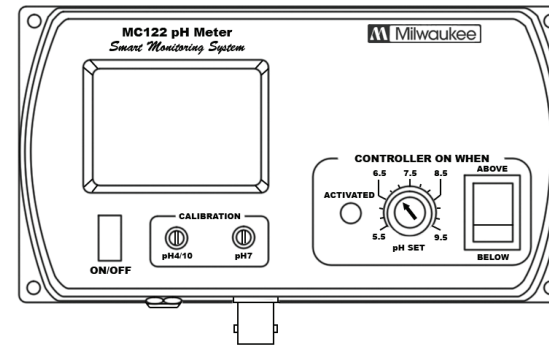

Smart Monitoring System

SPECIFICATIONS

	MC122 pH Meter	MP810 Peristaltic Dosing Pump
Range	0.0 to 14.0 pH	<ul style="list-style-type: none"> • Constant Dosing flow of 1,5 l/h (25 cc/min) • No regulation • Maximum pressure: 1 bar • Made of Polipropilene (PP) • Peristaltic tube in Santoprene • Power supply: 230 VAC ± 10%
Resolution	0.1 pH	
Accuracy	±0.2 pH (@25°C)	
Setpoint	5.5 to 9.5 pH	
Alarm / Output	active when measure is higher/lower than selected	
Power Socket	setpoint depending on user selection	
Power drivers	115VAC, 2A, 60Hz or 230VAC, 1A, 50Hz	
pH electrode	MA911B/2 (included)	
Environment	0 to 50°C, 95% RH not condensing	
Power supply	12 VDC (included)	
Dimensions	148.5 x 82.5 x 32 mm	
Weight	180 g	

INSTALLATION OF CONTROLLER:

Connect the supplied 240VAC/12VDC power adapter to the meter and to the main line.

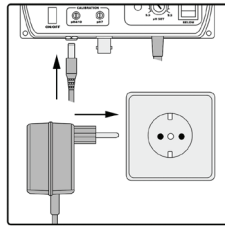

Connect the connection base (black and white outlet) to the main line.

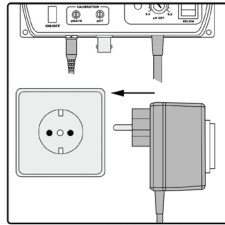

Connect the pH-electrode to the BNC socket on the bottom of the meter.

Always remove the electrode protective cap before taking any measurement. Make sure that the meter has been calibrated before taking any measurements

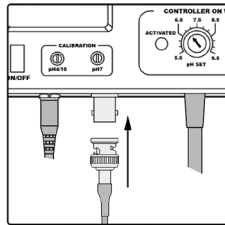

Immerse the tip (2.5 cm) of the pH-electrode into the sample. (for example it can float with the help of a piece of polystyrol).

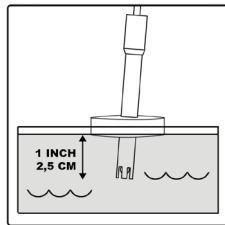

Turn the instrument on by pressing the ON/OFF button.

The nature of the setpoint can be selected by setting the switch to the desired position (ABOVE or BELOW).

Allow the reading to stabilize and the meter will start continuous monitoring.

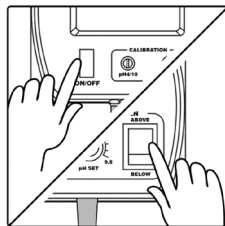

A blinking alarm will indicate when the measured pH value is higher or lower than selected setpoint, depending on user selection. When the alarm is activated, it also activates the connection base and the auxiliary equipment.

The setpoint can be selected by adjusting the central front knob to the desired value. The selectable range is from 5.5 to 9.5 pH.

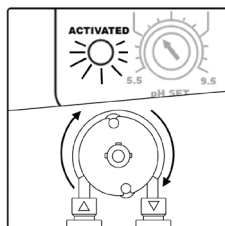

CALIBRATION:

- Remove the protective cap from the electrode.
- Immerse the electrode tip into a new sachet of pH 7 calibration solution and allow the reading to stabilize.
- Adjust the pH7 calibration trimmer (on the front) to display "7.0 pH".
- Rinse the electrode with tap water and dry it with paper tissue.
- Open a new sachet of pH 4 calibration solution, immerse the electrode tip into the sachet and allow the reading to stabilize.
- Adjust the pH4/10 calibration trimmer (on the front) to display "4.0 pH".

The calibration is now complete and the meter is ready to take measurements.

It is suggested to recalibrate the meter at least once a month, after a prolonged stocking time and after pH-electrode replacement.

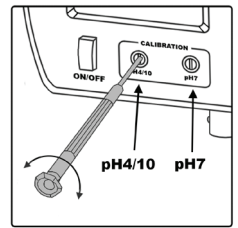
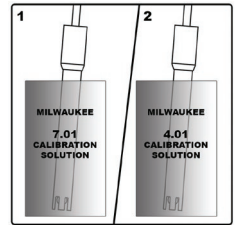
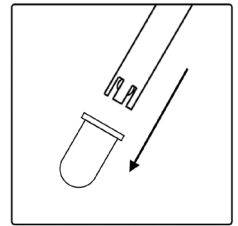

INSTALLATION OF THE MP810 1.5 L/H DOSING PUMP

Connect the rigid tube to the pump (aspiration – arrow upwards). Fix the white filter on the other end of the tube, where the dissolved pH reducing acid will be drawn in – to prevent small objects entering the pump.

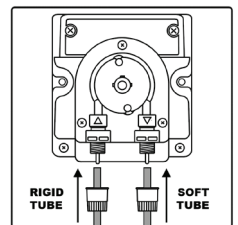

Connect the soft tube to the pump (impulsion – arrow downwards). The injection fitting will be placed at the end of this tube only to inject into a piping. (This fitting has a thread that links it to the piping.)

